

EXTEND-A-BUS™ for *DeviceNet™*

A Line of Fieldbus Extenders for DeviceNet

User Manual

#TD960801-0MD

CONTEMPORARY  **CONTROLS®**

Trademarks

Contemporary Controls, ARC Control, ARC DETECT and EXTEND-A-BUS are trademarks or registered trademarks of Contemporary Control Systems, Inc. ARCNET is a registered trademark of Datapoint Corporation. Other product names may be trademarks or registered trademarks of their respective companies.
TD960801-0MC Revised 07-16-02

Copyright

© Copyright April 1999-2007 by Contemporary Control Systems, Inc. All rights reserved. No part of this publication may be reproduced, transmitted, transcribed, stored in a retrieval system, or translated into any language or computer language, in any form or by any means, electronic, mechanical, magnetic, optical, chemical, manual, or otherwise, without the prior written permission of:

Contemporary Control Systems, Inc.
2431 Curtiss Street
Downers Grove, Illinois 60515 USA
Tel: +1-630-963-7070
Fax: +1-630-963-0109
E-mail: info@ccontrols.com
WWW: <http://www.ccontrols.com>

Contemporary Controls Ltd
Sovereign Court Two
University of Warwick Science Park
Sir William Lyons Road
Coventry CV4 7EZ UK
Tel: +44 (0)24 7641 3786
Fax: +44 (0)24 7641 3923
E-mail: info@ccontrols.co.uk

Disclaimer

Contemporary Control Systems, Inc. reserves the right to make changes in the specifications of the product described within this manual at any time without notice and without obligation of Contemporary Control Systems, Inc. to notify any person of such revision or change.

Contents

Chapter 1	Introduction	1
	1.1 Description	1
	1.2 Features	2
	1.3 Specifications	2
	1.4 Port Specifications	3
	1.5 Ordering Information	4
Chapter 2	Installation	5
	2.1 Introduction	5
	2.2 Electromagnetic Compliance	5
	2.3 Mounting the EXTEND-A-BUS	6
	2.4 Powering the EXTEND-A-BUS	6
	2.5 Connecting to the CAN Port	9
	2.6 Connecting to the Backbone Port	12
Chapter 3	Operation	19
	3.1 CAN Communications	19
	3.2 Theory of Operation	20
	3.3 System Considerations	23
	3.4 LED Indicators	25
Chapter 4	Service	27
	Warranty	27
	Technical Support	28
	Warranty Repair	28
	Non-Warranty Repair	29
	Returning Products for Repair	29
Appendices		
	Appendix A—Permissible Segment Lengths	31
	Appendix B—Declaration of Conformity	34

List of Figures

Figure 2-1	DC Powered	7
Figure 2-2	Redundant DC Powered	8
Figure 2-3	AC Powered	8
Figure 2-4	AC Powered with Battery Backup	9
Figure 2-5	CAN Port Connector Assignments	10
Figure 2-6	Data Rate Switch	11
Figure 2-7	Appropriate terminators are required at the ends of both the coaxial cable backbone and DeviceNet subnets	13
Figure 2-8	A maximum of eight EXTEND-A-BUSES can occupy one coaxial backbone segment before an .. active hub is required	14
Figure 2-9	A 62.5/125 μm duplex fiber optic cable is used on the -FOG model up to a maximum of 1830 meters	15
Figure 2-10	By using two AI3-CXS hubs, a distributed star topology is achieved	17

1 Introduction

1.1 Description

The EXTEND-A-BUS for DeviceNet series of fieldbus extenders enable the geographic expansion of CAN-based device networks such as DeviceNet by linking individual DeviceNet subnets together into a single larger network.

The medium arbitration method used by DeviceNet is intolerant of excessive signal delay. Since cable length introduces delay, DeviceNet networks tend to be distance limited. Repeaters are ineffective in extending distances since they introduce additional delay. On the other hand, fieldbus extenders like EXTEND-A-BUS solve the problem by segmenting a single DeviceNet network into manageable subnets.

EXTEND-A-BUS interconnects two physically separated but similar networks using a different interconnecting medium. Thus, a pair is required to interconnect two networks (or subnets) the way two modems are used on leased phone lines.

Utilizing ARCNET as the high-speed deterministic interconnecting medium, the EXTEND-A-BUS captures DeviceNet traffic and replicates it to the receiving device. The receiving device removes DeviceNet data and rebroadcasts the data to its attached DeviceNet subnet. EXTEND-A-BUS does not filter out DeviceNet identifiers or MAC addresses, so DeviceNet messages are rebroadcast unmodified.

Application Information

Each EXTEND-A-BUS creates a DeviceNet subnet and a minimum of two EXTEND-A-BUSES is required to establish a network. The data rate on each subnet can be different from the other subnets. DeviceNet identifiers or MAC ID checks are replicated on all subnets. EXTEND-A-BUS pairs are best viewed as an extension cord. Each EXTEND-A-BUS does not consume a permanent MAC ID and, therefore, is transparent to the network.

Extending the Interconnecting Medium or Backbone

The backbone side of the EXTEND-A-BUS must comply with standard ARCNET cabling rules. Companion AI ARCNET active hubs are available for extending the backbone cabling up to 6 km using coaxial cabling and ten active hubs. When using a fiber optic backbone, a maximum of 4.8 km can be achieved requiring two active hubs. Hubs are cascaded to reach the required distance.

1.2 Features

- Extends the length of DeviceNet networks up to 6 km
- Fully DeviceNet compliant
- Fiber optic or coaxial cabling
- Star, bus or distributed star topology
- Variable data rate up to 500 kbps
- Low voltage AC or DC powered
- Panel-mount enclosure

1.3 Specifications

Electrical

	DC	AC
Input voltage:	10–36 volts	8–24 volts
Input power:	4 watts	4 VA
Input frequency:	N/A	47–63 Hz

Power Options

- DC powered
- Redundant powered
- AC powered
- AC powered with battery backup

Environmental

Operating: 0°C to 60°C

Storage: -40°C to +85°C

Functional

Data latency: 1.2 ms typical per EXTEND-A-BUS pair

Regulatory Compliance

CFR 47, Part 15 Class A

CE Mark

1.4 Port Specifications

	CAN Port
Compliance	DeviceNet Volume I, Release 2.0
Data Rate	125 kbps, 250 kbps, 500 kbps selectable or
Autobaud	125 kbps, 250 kbps, 500 kbps
LEDs	CAN status: Module status/network status
Transceivers	Optically isolated 82C251
Cable	DeviceNet Thick
Connectors	5 position Open-pluggable
Maximum segment or subnet distance	125 kbps: 500 meters (1640 ft) 250 kbps: 250 meters (820 ft) 500 kbps: 100 meters (328 ft)
Maximum number of nodes per segment	64
Terminating resistor	121 ohms

	Backbone Port
Compliance	ARCNET ANSI/ATA 878.1
Data Rate	2.5 Mbps

LEDs	Link status:
	Reconfiguration status/activity status
Transceivers	-CXB model: transformer coupled
	-FOG model: 850 nm duplex fiber optic
Cable	-CXB model: RG-62/u coaxial
	-FOG model: 62.5/125 μ m duplex fiber optic
Connectors	-CXB model: BNC
	-FOG model: ST TM
Maximum segment or subnet distance	-CXB model: 305 meters (1000 ft)
	-FOG model: 1830 meters (6000 ft) (optical power budget 10.4 dB)
Maximum number of nodes per segment	-CXB model: 8
	-FOG model: N/A
Terminating resistor	-CXB model: 93 ohms
	-FOG model: N/A

1.5 Ordering Information

The EXTEND-A-BUS series is available in several configurations depending upon the application and cable media supported.

EXTEND-A-BUSes:

EB/DNET-CXB EXTEND-A-BUS with coaxial bus backbone
 EB/DNET-FOG EXTEND-A-BUS with fiber optic backbone

Accessories:

AI-XFMR Wall-mount transformer 120 VAC (nom)
 AI-XFMR-E Wall-mount transformer 240 VAC (nom)
 AI-DIN DIN-rail mounting kit
 BNC-T BNC "T" connector
 BNC-TER 93-ohm BNC terminator

2 Installation

2.1 Introduction

The EXTEND-A-BUS series is intended to be panel mounted into an industrial enclosure or into a wiring closet. Two #8 pan head screws (not provided) are required for mounting. Optionally, the bridge can be mounted on a DIN rail by purchasing a DIN rail mounting kit.

2.2. Electromagnetic Compliance

The EXTEND-A-BUS series complies with Class A radiated and conducted emissions as defined by CFR 47, Part 15 and EN55022. This equipment is intended for use in non-residential areas. Refer to the following notices in regard to the location of the installed equipment.

Note: This equipment has been tested and found to comply with the limits for a Class A digital device, pursuant to CFR 47, Part 15. These limits are designed to provide reasonable protection against harmful interference when the equipment is operated in a commercial environment. This equipment generates, uses, and can radiate radio frequency energy and, if not installed and used in accordance with the instruction manual, may cause harmful interference to radio communications. Operation of this equipment in a residential area is likely to cause harmful interference in which case the user will be required to correct the interference at his own expense.

Warning

This is a Class A product as defined in EN55022. In a domestic environment this product may cause radio interference in which case the user may be required to take adequate measures.

The EXTEND-A-BUS has been tested to EN50082 Generic Immunity Standard–Industrial Environment. This standard identifies a series of tests requiring the equipment to perform to a particular level during or after the execution of the tests. The three classes of performance are defined by CCSI as follows:

Class A - Normal operation, however, occasional reconfigurations may occur or throughput may be reduced due to an error recovery algorithm by the ARCNET data link level protocol.

Class B - Throughput reduced to zero and continuous reconfigurations occur. Normal operation resumed after offending signal removed.

Class C - Complete loss of function. Unit resets and normal operation restored without human intervention.

At no time did the EXTEND-A-BUS fail to return to normal operation or become unsafe during the execution of these tests.

A copy of the Declaration of Conformity is in the appendix.

2.3 Mounting the EXTEND-A-BUS

The EXTEND-A-BUS can be snap-mounted onto TS-35 DIN-rail. If the DIN-rail clip is removed, the unit can be secured in an industrial enclosure or wiring closet using the provided brackets and #8 pan-head screws (not provided).

2.4 Powering the EXTEND-A-BUS

The EXTEND-A-BUS requires either low voltage AC or DC power in order to operate. Consult the specifications for power requirements. Power is provided to a four pin removable keyed connector. There are several methods for providing power. These methods are DC powered, redundant DC powered, AC powered and AC powered with battery backup.

2.4.1 DC Powered

Make connections as shown in Figure 2-1. The EXTEND-A-BUS incorporates a DC-DC converter that accepts a wide voltage range (10–36 VDC) and converts the voltage for internal use. Input current varies with input voltage so it is important to size the power conductors accordingly. Input power to the EXTEND-A-BUS maximizes at 4 watts; therefore, at 10 VDC, the input current is approximately 400 mA. The ground connection to the EXTEND-A-BUS is connected to chassis within the EXTEND-A-BUS. The input connections are reverse-voltage protected.

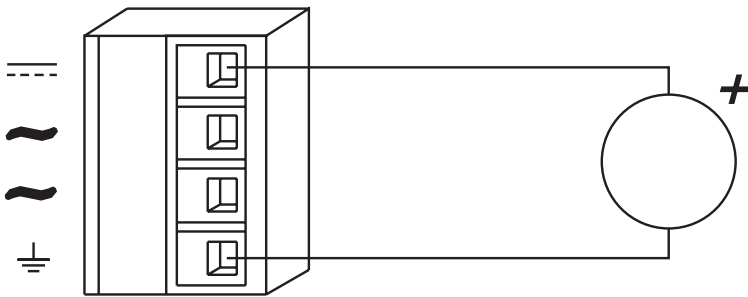

Figure 2-1. DC Powered

2.4.2 Redundant DC Powered

Redundant diode isolated DC power inputs are provided on the EXTEND-A-BUS for those applications in which there is a concern that the EXTEND-A-BUS remain operational in the event of a primary power failure. Make connections as shown in Figure 2-2. Each power supply source must be sized for the full 4-watt load of the EXTEND-A-BUS. Do not assume that input currents will be balanced from the two supplies.

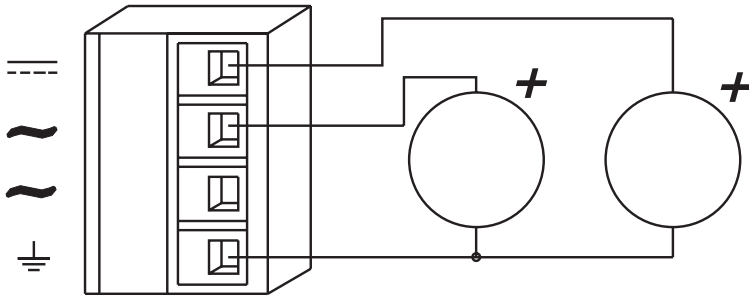

Figure 2-2. Redundant DC Powered

2.4.3 AC Powered

If only AC power is available, the EXTEND-A-BUS can be powered by the secondary of a low voltage transformer whose primary is connected to the AC mains. The secondary voltage must be in the range of 8 to 24 VAC, 47–63 Hz with the capability of delivering up to 4 VA of apparent power. The secondary of the transformer must not be grounded. For convenience, two auxiliary power supplies are available:

- AI-XFMR for 120 VAC primary power
- AI-XFMR-E for 240 VAC primary power

Reference Figure 2-3.

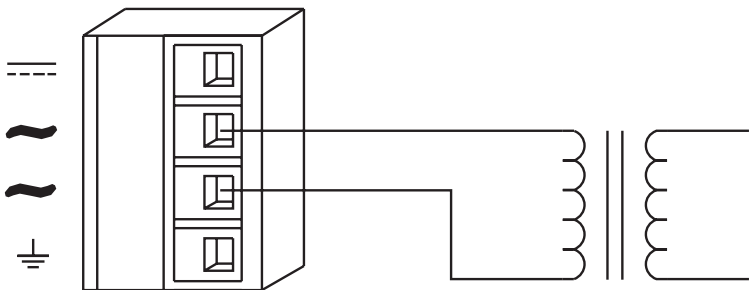

Figure 2-3. AC Powered

2.4.4 AC Powered with Battery Backup

The EXTEND-A-BUS can also be powered from both an AC and DC power source. Usually, the DC source is from a battery supply which is connected as the DC powered option. Refer to Figure 2-4. In this application, the EXTEND-A-BUS does not charge the battery so separate provisions are required for charging. If the AC source fails, the EXTEND-A-BUS will operate from the battery source.

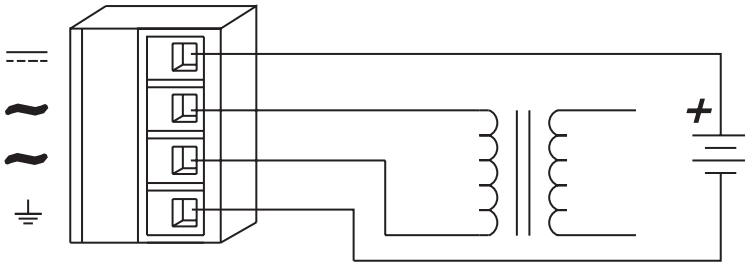

Figure 2-4. AC Powered with Battery Backup

2.5 Connecting to the CAN Port

The CAN port complies to the DeviceNet physical layer specification for an isolated port. Since the port is isolated, bus power (V+, V-) must be present in order for the port to function. A bus power sensor has been provided in the EXTEND-A-BUS to ensure that in the absence of bus power, the port will not enter the “bus off” state.

2.5.1 CAN Port Assignments

A five position open style male connector has been provided on the EXTEND-A-BUS for connections. See figure 2-5 for connector assignments. A mating female connector has been provided in order to make field connections.

Terminators are required at the ends of trunk cables. If the EXTEND-A-BUS is located at the end of a trunk and no terminator is present, a discrete resistor terminator (121 ohms) can be connected under the screw terminals for CAN_H and CAN_L.

Refer to Figure 2-5 for wiring details.

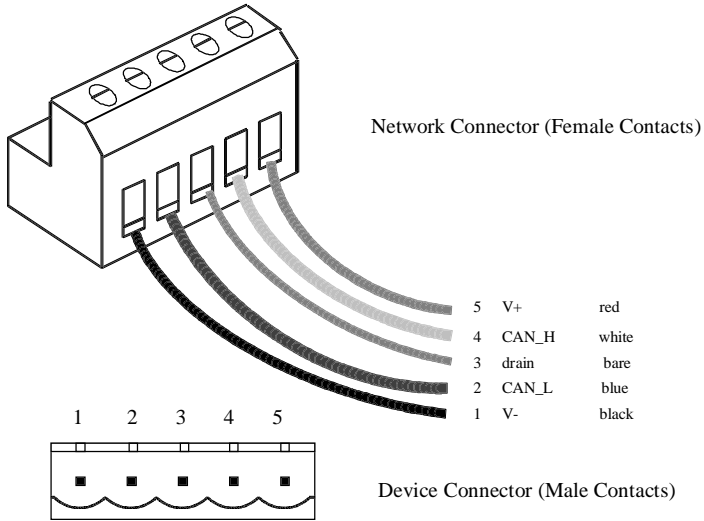

Figure 2-5. CAN Port Connector Assignments

2.5.2 CAN Port Data Rates

Several data rates can be selected by a rotary switch as shown in figure 2-6. Switch positions are labeled A, S, 125, 250, 500. A and S are used to implement autobauding which will be discussed later. The remaining positions determine a fixed data rate in units of kbps. Therefore, the lowest rate is 125 kbps and the highest is 500 kbps. The data rate switch is only read upon power up; so to change settings, the switch position should be changed and the power cycled to the EXTEND-A-BUS. A clockwise rotation increases the data rate setting.

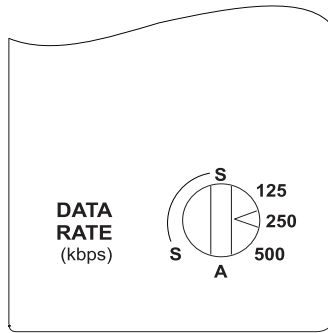

Figure 2-6. Data Rate Switch

2.5.3 Autobauding

Autobauding is the action of automatically matching the data rate of the EXTEND-A-BUS to the data rate of a master controller or scanner in a DeviceNet network. By moving the Data Rate switch to the A position and powering up the EXTEND-A-BUS, the EXTEND-A-BUS will attempt to determine the data rate by observing the traffic on the CAN port. Therefore, it is important that the CAN port be connected to the DeviceNet subnet connecting the master controller. All other EXTEND-A-BUSES should have their Data Rate switch set to S (slave) position since their data rate will be set by the master EXTEND-A-BUS (the one connected to the master) which will broadcast the required data rate to all slaves once the data rate is determined. Autobauding functions for the three data rates: 125, 250 and 500 kbps.

2.6 Connecting to the Backbone Port

The backbone (link) port is ARCNET compliant and, therefore, complies with the cabling rules for ARCNET networks. For more information on designing an ARCNET cabling system, refer to Contemporary Controls' publication, "*ARCNET Tutorial & Product Guide.*"

Either of two transceivers are available on the backbone port. The coaxial bus (-CXB) transceiver requires coaxial cable allowing a total of eight EXTEND-A-BUS devices to be connected onto one wiring segment. The fiber optic (-FOG) transceiver allows for two EXTEND-A-BUSes to be connected in a point-to-point or link fashion. If star or distributed star topologies are desired or if the cabling distances must exceed the basic specifications, ARCNET compliant active hubs are required. Contemporary Controls provides two series of active hubs—the MOD HUB series of modular hubs and the AI series of fix port hubs. Refer to the appendix for more information on active hubs.

2.6.1 Connecting Coaxial Bus Networks (-CXB)

Coaxial bus backbone ports must be interconnected with RG-62/u 93-ohm coaxial cable. In a simple two EXTEND-A-BUS arrangement, a BNC-Tee (BNC-T) is twisted onto each BNC backbone port. A length of RG-62/u cable, no shorter than 6 feet (2 m) nor longer than 1000 feet (305 m) is connected between the BNC-Tee connectors. At the open end of each BNC-Tee is connected a 93-ohm terminator (BNC-TER). This completes the basic connection.

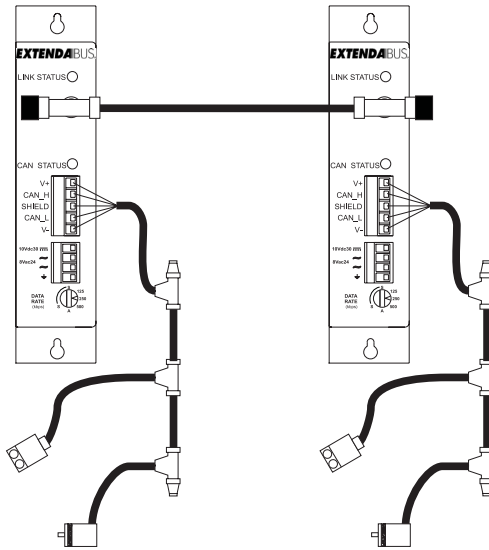

Figure 2-7. Appropriate terminators are required at the ends of both the coaxial cable backbone and DeviceNet subnets.

More than two EXTEND-A-BUSES (but no more than eight) can be connected to one wiring segment. Insert the desired number of EXTEND-A-BUSES using BNC-Tee connectors to the backbone wiring. Make sure that any two EXTEND-A-BUSES are separated by at least 6 foot (2 m) of cable and that the complete cabling segment does not exceed 1000 feet (305 m).

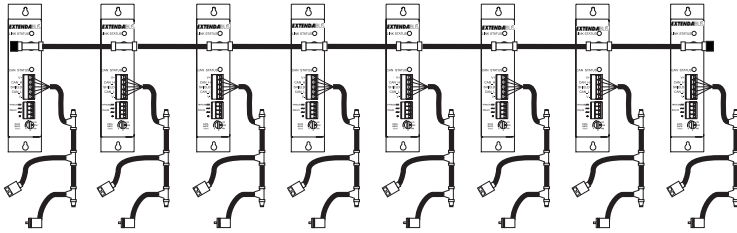

Figure 2-8. A maximum of eight EXTEND-A-BUSes can occupy one coaxial backbone segment before an active hub is required. Use BNC “Tees” and terminators when making connections. One of each is included in the -CXB model.

2.6.2 Connecting Fiber Optic Cable (-FOG)

Multimode fiber optic cable is typically available in three sizes, 50/125, 62.5/125, and 100/140. The larger the size, the more energy that can be launched and, therefore, the greater the distance. Bayonet style ST connectors, similar in operation to BNC coaxial cable connectors, are provided for making the fiber connections.

Fiber optic connections require a duplex cable arrangement. Two unidirectional cable paths provide the duplex link. There are two devices on the EXTEND-A-BUS fiber port. One device, colored light gray, is the transmitter and the other, dark gray, is the receiver. Remember that “light goes out of the light (gray).” To establish a working link between an EXTEND-A-BUS and another EXTEND-A-BUS or an EXTEND-A-BUS to a hub, the transmitter of point A must be connected to a receiver at point B. Correspondingly the receiver at point A must be connected to a transmitter at point B. This establishes the duplex link which is actually two simplex links. Fiber optic cable is available paired for this purpose. Usually the manufacturers' labeling is only on one cable of the pair which is handy for identifying which of the two cables is which. Establish your own protocol

for connecting cable between hubs and EXTEND-A-BUSES in the field using the manufacturers' labeling as a guide. However, remember that to connect point A to point B requires a paired fiber optic cable and that the light gray connector at one point must connect to a dark gray connector at the other point.

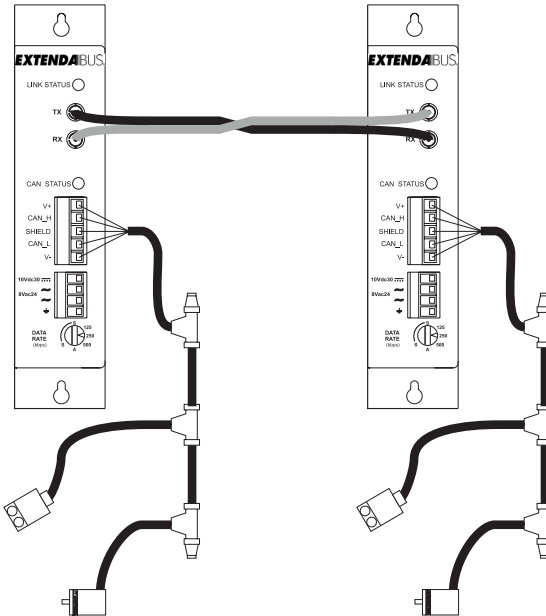

Figure 2-9. A 62.5/125 μm duplex fiber optic cable is used on the -FOG model up to a maximum of 1830 meters.

2.6.3 *Extending the Backbone*

The backbone side of the EXTEND-A-BUS must comply with standard ARCNET cabling rules. Companion AI ARCNET active hubs are available for extending the backbone cabling up to 6 km using coaxial cabling and ten active hubs. When using a fiber optic backbone, a maximum of 4.8 km can be achieved requiring two active hubs. Hubs can be cascaded to reach the required distance.

By using active hubs, star and distributed star topologies are possible. There is, however, a limit to the overall length of the backbone network. The delay experienced when an EXTEND-A-BUS communicates to another EXTEND-A-BUS with each located at the extreme ends of a network cannot exceed 31 μ s. This delay is due to cable and hub delays. This delay translates to a maximum of 6 km of coaxial cable or 4.8 km of fiber optic cable. When making this calculation, only consider the distance between the two furthest EXTEND-A-BUSes. Also verify the distance limitations of active hubs being used. Active hubs that incorporate coaxial star ports (-CXS) allow for 2000 foot connections between compatible ports but no bussing. When making a connection to a -CXS port from the EXTEND-A-BUS' -CXB port, make sure that the -CXS port is located at one end of the segment and that no terminator is used. The length of a segment connecting a -CXB port cannot exceed 1000 feet (305 m).

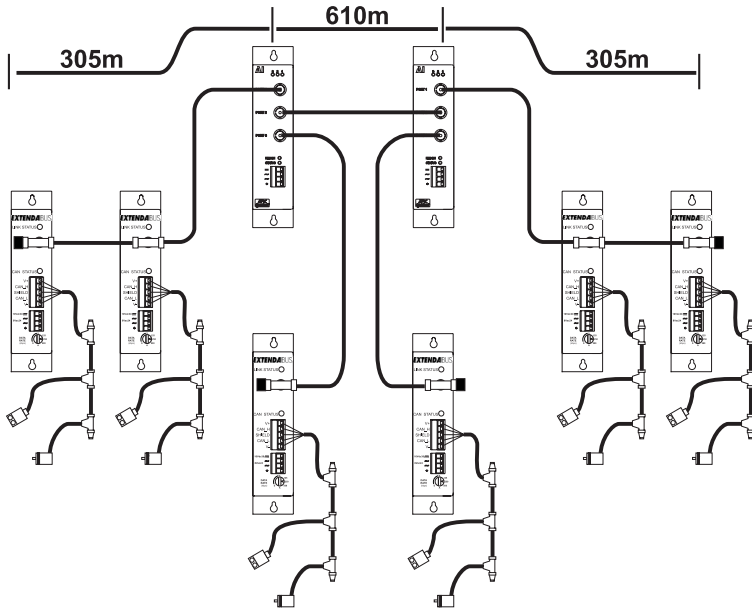

Figure 2-10. By using two AI3-CXS hubs, a distributed star topology is achieved. Note that the hub-to-hub distance can be a maximum of 610 m when using coaxial cable and that no terminators are used at the AI3 ports. However, the cables to the EXTEND-A-BUSES still cannot exceed 305 m.

3 Operation

3.1 CAN Communications

CAN was designed by Bosch and is currently described by ISO 11898. In terms of the Open Systems Interconnection model (OSI), CAN partially defines the services for layer 1 (physical) and layer 2 (data link). Other standards such as DeviceNet, Smart Distributed System and CANopen (collectively called higher layer protocols) build upon the basic CAN specification and define additional services of the seven layer OSI model. Since all of these protocols utilize CAN integrated circuits, they therefore all comply with the data link layer defined by CAN.

CAN specifies the medium access control (MAC) and physical layer signaling (PLS) as it applies to layers 1 and 2 of the OSI model. Medium access control is accomplished using a technique called non-destructive bit-wise arbitration. As stations apply their unique identifier to the network, they observe if their data is being faithfully produced. If it is not, the station assumes that a higher priority message is being sent and, therefore, halts transmission and reverts to receiving mode. The highest priority message gets through and the lower priority messages are resent at another time. The advantage of this approach is that collisions on the network do not destroy data and eventually all stations gain access to the network. The problem with this approach is that the arbitration is done on a bit by bit basis requiring all stations to hear one another within a bit time (actually less than a bit time). At a 500 kbps bit-rate, this time is less than 2000 ns which does not allow much time for transceiver and cable delays. The result is that CAN networks are usually quite short and frequently less than 100 meters in length at higher speeds. To increase this distance either the data rate is decreased or additional equipment is required.

3.1.1 Repeaters

The usual approach to increasing network distance is to use repeaters. Repeaters provide signal boost to make up the loss of signal strength on a long segment. However, the problem with long CAN segments is usually not lack of signal strength but excessive signal latency. This latency is due to the propagation delay introduced by the transceivers and twisted-pair wiring. If this latency approaches one bit time, the non-destructive bit-wise arbitration mechanism fails. Repeaters actually introduce more delay due to the additional electronics and are not effective in increasing the overall length of CAN networks. Repeaters are generally used to increase the effective length of drop cables from CAN trunk lines. Repeaters operate on the physical layer.

3.1.2 Bridges

Bridges are defined as devices that link two similar networks, however, bridges can mean different things to different people so further clarification is necessary. A local bridge stands by itself connecting adjacent wiring segments together as in the case of a repeater. Remote bridging interconnects two physically separated but similar networks together using a different interconnecting medium. Therefore, a pair of bridges are required to interconnect two networks the way two modems are used on leased phone lines. Sometimes bridges block network traffic by restricting data only to stations specified in the transmission that reside on the network controlled by the bridge. This blocking is difficult to implement in broadcast networks such as CAN and, therefore, not recommended. Bridges are ignorant of the higher level protocols sent over CAN since bridges operate at the data link layer. Therefore, protocols such as DeviceNet, Smart Distributed System and CANopen are passed without modification.

3.2 Theory of Operation

The EXTEND-A-BUS is classified as a remote bridge and contained in a two piece metal enclosure suitable for panel

mounting into a larger industrial enclosure. As an option, the EXTEND-A-BUS can be DIN rail mounted by purchasing the appropriate kit. The EXTEND-A-BUS has two ports, one for the CAN network and the other for the ARCNET backbone. The device can be powered from either a low voltage AC or DC power supply.

3.2.1 CAN Port

One electrically isolated CAN port has been provided capable of operating to the DeviceNet physical layer specification. This was done to minimize ground loop problems while providing isolation to the ARCNET backbone. The port conforms to the DeviceNet specification for a five position unsealed connector. One CAN segment, conforming to the electrical restrictions of the CAN segment, attaches to this port. In a similar method, additional CAN segments are attached to other EXTEND-A-BUS CAN ports. The only restriction is that all CAN compliant devices on the complete network have unique MAC IDs.

3.2.2 ARCNET Port

On the coaxial cable model, a BNC connector has been provided. On the fiber optics model, two ST connectors are provided—one for transmit (TX) and one for receive (RX). The coaxial port is of the high impedance type (-CXB) allowing for up to eight devices on one coaxial cable segment. A BNC terminator (BNC-TER) and a BNC Tee connector (BNC-T) are provided to facilitate connections to other bridges on the ARCNET backbone. The ARCNET port operates at 2.5 Mbps. Each EXTEND-A-BUS requires a unique ARCNET node ID which has no meaning to the CAN segments. Node ID's are automatically assigned by the EXTEND-A-BUSES themselves using an arbitration scheme upon power up.

3.2.3 *Topologies*

CAN-based device networks usually operate over a multidrop topology with provisions for short drops of typically six meters each. The trunk length depends upon the data rate and at 500 kbps, the maximum length of the trunk is 100 meters. Conceptually, the multidrop topology is easy to understand and appears easy to implement and for many applications this is true. However, for some machines or processes, the star or distributed star topology would reduce wiring especially when devices are clustered in all directions from the main control panel. By incorporating bridges, the multidrop topology is maintained since the ARCNET side of the bridges are bused; however, since each CAN segment attached to a bridge can comply with the maximum capabilities of the CAN segment, a system is created with a long ARCNET trunk of 1000 feet and eight long CAN “drop” segments of 330 feet each. If a true star topology or longer distances are desired, each EXTEND-A-BUS can be connected to a companion AI series active hub. For distributed star topologies, multiple AI series active hubs can be cascaded up to the ARCNET limit of four miles when using coaxial cable. With increased distances comes increased signal latency and potential real time performance degradation of the network.

3.2.4 *Power Requirements*

Either low voltage AC or DC power will power the EXTEND-A-BUS. A DC-DC converter accepts the input power and converts it to +5 volts DC for use by the EXTEND-A-BUS. The AC power must come from a floating secondary in the range of 8 to 24 volts AC. The DC power source must be in the range of 10 to 36 VDC. Power connections are derived from a four position unsealed connector. The CAN port must still be powered from the network itself since the EXTEND-A-BUS does not serve as a network power supply; however, the EXTEND-A-BUS can be powered from the 24 volt network power supply.

3.2.5 *EXTEND-A-BUS Engine*

A high speed 32 Mhz 80C188 microprocessor provides the computing power for the EXTEND-A-BUS. The ARCNET port consists of a 20020 controller chip and coaxial bus or fiber optic transceiver. The CAN port consists of a Intel 82527 CAN controller and isolated 82C251 transceiver. The CAN port is capable of generating interrupts at a high speed since the EXTEND-A-BUS must listen to all CAN traffic. Back to back CAN data frames can generate an interrupt every 94 μ s at 500 kbps. The ARCNET buffers will also generate interrupts making low latency interrupt handling a priority for the EXTEND-A-BUS. Included in the engine is a 128Kx8 FLASH ROM and 128Kx8 SRAM. An internal serial port is used to update the firmware.

3.3 **System Considerations**

There are some design considerations when implementing a remote bridging system.

By its very nature of storing and forwarding messages, the EXTEND-A-BUS system introduces additional signal latency which may disturb DeviceNet systems with tight timing constraints. With the DeviceNet protocol, there has been little evidence of any timing problems. However, the potential exists for a system to erroneously signal a failed response to an action when short cabling delays are assumed. On systems with very fast DeviceNet scanners while operating at low data rates and lightly load systems, the possibility exists for the master to issue a comment to a slave and fail to wait for the slave's response before issuing another command assuming a failed response. This is especially true for devices that support long fragmented messages. The solution is to increase the interscan time to either 5 to 10 ms in order to allow sufficient time for response. Another solution is to increase the data rate on all devices to 500 kbps. Still another solution is to move problem devices to the local segment (the same segment as the scanner) in order to eliminate delays due to the EXTEND-A-BUSes.

Within a CAN segment, at least one device must acknowledge the valid receipt of another device's transmission. That acknowledgment, however, does not extend beyond an EXTEND-A-BUS. Even though a successful transmission occurred on a CAN segment, that transmission must be replicated on all other CAN segments generating additional acknowledgments. Therefore, it is possible that a replicated transmission on one CAN segment may fail due to a cabling problem resulting in no acknowledgment while all other CAN segments view the transmission successful. However, the DeviceNet protocol does not rely upon the CAN data link acknowledgment as sole indication of a successful transmission. Additional error checking has been incorporated in the upper layer DeviceNet protocol.

Single nodes can operate on an individual CAN segment with remote bridging. Since each EXTEND-A-BUS has one internal CAN chip, this CAN chip acknowledges the single node's message. Without remote bridges, a single node will fail to hear an acknowledgment and will continuously retry.

The DeviceNet protocol supports autobauding which is possible for the EXTEND-A-BUS to implement. One EXTEND-A-BUS acts as a master for all other bridges on the network functioning as slaves. The master EXTEND-A-BUS must be connected to the CAN segment connected to the master controller. As the master controller transmits data, the master EXTEND-A-BUS determines the data rate and informs all other EXTEND-A-BUSes the required data rate over the ARCNET connection. Once the data rates are determined, traffic is sent between the bridges functioning as one long extension cord. The EXTEND-A-BUS data rates can be manually set by way of a switch and there is no inherent reason why individual CAN segments cannot be set to different data rates.

Using the same extension cord analogy, it would appear that a remote bridging system must be powered before or at the same time as the slave devices or master controller in order that all devices can execute initialization routines such as duplicate

MAC ID tests as in the case of DeviceNet. However, if a remote bridge loses power while all other devices remain powered, the failure mode should be no different than cutting the cable in the middle of a CAN segment. When power is restored to the remote bridges, the restart sequence should be the same as if the maintenance person reconnected a disconnected cable.

CAN networks are usually configured in a bus or multidrop topology while ARCNET can be configured as a bus, star or distributed star topology. Therefore CAN implementations can take advantage of the more flexible ARCNET cabling options. Do not cascade EXTEND-A-BUSES beyond two since the delay stackup could be excessive. Instead connect all EXTEND-A-BUSES in a star topology using a hub thereby reducing data latency to that of two EXTEND-A-BUSES.

Implementing fiber optics over any reasonable distance with CAN is difficult due to the increased delays caused by the additional circuitry. However, fiber optic ARCNET solutions are readily available. Therefore, the benefits of fiber optics can be gained simply by adding remote bridges. Note that the propagation delay of fiber optic cable (5 ns/m) is 25% more than that of coaxial cable. This is important when calculating ARCNET delay margin and was considered when setting the 4.8 km fiber optic limit.

3.4 LED Indicators

One CAN Status LED and one LINK Status LED are provided in order to convey information regarding their respective ports. When LEDs flash, they will flash approximately at a rate of 0.5 seconds on and 0.5 seconds off.

3.4.1 CAN Status LED

A dual color LED (red/green) is used to identify status of the CAN port. After a power-on sequence, the LED indications are as follows:

RED—The EXTEND-A-BUS has detected an internal problem with the CAN port requiring service.

Flashing RED—The CAN port does not have sufficient voltage on its V+ and V– lines to power the optically isolated port.

GREEN—The CAN port is receiving data.

Flashing GREEN—The CAN port is commissioned, however, no CAN data has been received in over a second.

3.4.2 *LINK Status LED*

A dual color LED (yel/green) is used to identify status of the ARCNET (backbone) port. After a power-on sequence, the LED indications are as follows:

YELLOW—Continuous network configuration occurring or no other EXTEND-A-BUS nodes found.

Flashing YELLOW—One or more network reconfigurations detected on an operating network.

GREEN—Data is being received from the network.

Flashing GREEN—Network is operational, however, no data is being received from the network in the last second.

3.4.3 *Power-on LED Sequence*

The CAN Status and LINK Status LEDs are sequenced upon power-up to verify the integrity of the LEDs. The sequence is as follows:

CAN status off and Link status off
CAN status GREEN for 0.25 seconds
CAN status RED for 0.25 seconds
LINK status GREEN for 0.25 seconds
LINK status YELLOW for 0.25 seconds

After the power-on sequence, both LEDs assume their normal operation.

4 Service

NEED MORE HELP INSTALLING THIS PRODUCT?

More comprehensive information can be found on our web site at www.ccontrols.com. Browse the Technical Support section of our site for a look at our interactive on-line technical manuals, downloadable software drivers and utility programs that can test the product. When contacting one of our offices, just ask for technical support.

Warranty

Contemporary Controls (CC) warrants its new product to the original purchaser for two years from the product shipping date. Product returned to CC for repair is warranted for one year from the date that the repaired product is shipped back to the purchaser or for the remainder of the original warranty period, whichever is longer.

If a CC product fails to operate in compliance with its specification during the warranty period, CC will, at its option, repair or replace the product at no charge. The customer is, however, responsible for shipping the product; CC assumes no responsibility for the product until it is received.

CC's limited warranty covers products only as delivered and does not cover repair of products that have been damaged by abuse, accident, disaster, misuse, or incorrect installation. User modification may void the warranty if the product is damaged by the modification, in which case this warranty does not cover repair or replacement.

This warranty in no way warrants suitability of the product for any specific application. **IN NO EVENT WILL CC BE LIABLE FOR ANY DAMAGES INCLUDING LOST PROFITS, LOST SAVINGS, OR OTHER INCIDENTAL OR CONSEQUENTIAL DAMAGES ARISING OUT OF THE USE OR INABILITY TO USE THE PRODUCT EVEN IF CC HAS BEEN ADVISED OF THE POSSIBILITY OF SUCH DAMAGES, OR FOR ANY CLAIM BY ANY PARTY OTHER THAN THE PURCHASER.**

THE ABOVE WARRANTY IS IN LIEU OF ANY AND ALL OTHER WARRANTIES, EXPRESSED OR IMPLIED OR STATUTORY, INCLUDING THE WARRANTIES OF MERCHANTABILITY, FITNESS FOR PARTICULAR PURPOSE OR USE, TITLE AND NONINFRINGEMENT.

Repair or replacement as provided above shall be the purchaser's sole and exclusive remedy and CC's exclusive liability for any breach of warranty.

Technical Support

Contemporary Controls (U.S.A.) will provide technical support on its products by calling 1-630-963-7070 each weekday (except holidays) between 8:00 a.m. and 5:00 p.m. Central time. Contemporary Controls Ltd (U.K.) will provide technical support on its products by calling +44 (0)24 7641 3786 each weekday (except holidays) between 8:00 a.m. and 5:00 p.m. United Kingdom time. If you have a problem outside these hours, leave a voice-mail message in the CC after hours mailbox after calling our main phone number. You can also fax your request by calling 1-630-963-0109 (U.S.) or +44 (0)24 7641 3923 (U.K.), or contact us via e-mail at info@ccontrols.com or info@ccontrols.co.uk. You can visit our web site at www.ccontrols.com. When contacting us, please leave a detailed description of the problem. We will contact you by phone the next business day or in the manner your instructions indicate. We will attempt to resolve the problem over the phone. If unresolvable, the customer will be given an RMA number in order that the product may be returned to CC for repair.

Warranty Repair

Products under warranty that were not subjected to misuse or abuse will be repaired at no charge to the customer. The customer, however, pays for shipping the product back to CC while CC pays for the return shipment to the customer. CC normally ships ground. International shipments may take longer. If the product has been determined to be misused or abused, CC will provide the customer with a quotation for repair. No work will be done without customer approval.

Non-Warranty Repair

CC provides a repair service for all its products. Repair charges are based upon a fixed fee basis depending upon the complexity of the product. Therefore, Customer Service can provide a quotation on the repair cost at the time a Returned Material Authorization (RMA) is requested. Customers pay the cost of shipping the defective product to CC and will be invoiced for the return shipment to their facility. No repair will be performed without customer approval. If a product is determined to be unrepairable, the customer will be asked if the product can be replaced with a refurbished product (assuming one is available). Under no circumstances will CC replace a defective product without customer approval. Allow ten working days for repairs.

Returning Products for Repair

To schedule service for a product, please call CC Customer Service support directly at 1-630-963-7070 (U.S.) or +44 (0)24 7641 3786 (U.K.). *Have the product model and serial number available, along with a description of the problem.* A Customer Service representative will record the appropriate information and issue, via fax, an RMA number—a code number by which we track the product while it is being processed. Once you have received the RMA number, follow the instructions of the Customer Service support representative and return the product to us, freight prepaid, with the RMA number clearly marked on the exterior of the package. If possible, reuse the original shipping containers and packaging. In any event, be sure you follow good ESD-control practices when handling the product, and ensure that antistatic bags and packing materials with adequate padding and shock-absorbing properties are used. CC is not responsible for any damage incurred from improper packaging. Shipments should be insured for your protection.

Ship the product, freight prepaid, to the location from which it was purchased:

Contemporary Control Systems, Inc.
2431 Curtiss Street
Downers Grove, IL 60515
U.S.A.

Contemporary Controls Ltd
Sovereign Court Two
University of Warwick Science Park
Sir William Lyons Rd.
Conventry CV4 7EZ
U.K.

Appendices

Appendix A—Permissible Segment Lengths

A segment is defined as any portion of the complete ARCNET cabling system isolated by one or more hub ports. On a hubless or bus system, the complete ARCNET cabling system consists of only one segment with several nodes; however, a system with hubs has potentially many segments. An ARCNET node is defined as a device with an active ARCNET controller chip requiring an ARCNET device address. Active and passive hubs do not utilize ARCNET addresses and, therefore, are not nodes. Each segment generally supports one or more nodes, but in the case of hub-to-hub connections there is the possibility that no node exists on that segment.

The permissible cable length of a segment depends upon the transceiver used and the type of cable installed. Table A-1 provides guidance on determining the constraints on cabling distances as well as the number of nodes allowed per bus segment.

The maximum segment distances are based upon nominal cable attenuation figures and worst case transceiver power budgets. Assumptions are noted.

When approaching the maximum limits, a link loss budget calculation is recommended.

When calculating the maximum number of nodes on a bus segment, do not count the hub ports that terminate the bus segments nodes.

Do consider the maximum length of the bus segment to include the cable attached to the hub ports.

The -CXB transceiver requires a minimum distance between nodes. Adhere to this minimum since unreliable operation can occur.

Appendix A (continued)

Permissible Cable Lengths and Nodes Per Segment			
Trans- ceiver	Description	Cable	Connectors
-CXS	coaxial star	RG-62/u	BNC
-CXB	coaxial bus	RG-62/u	BNC
-FOG	duplex fiber optic	50/125	ST
-FOG	duplex fiber optic	62.5/125	ST
-FOG	duplex fiber optic	100/140	ST

¹ This represents the minimum distance between any two nodes or between a node and a hub.

² May require a jumper change on the EXTEND-A-BUS to achieve this distance.

*Table A-1. Permissible Cable Length
and Nodes Per Segment*

(2.5 Mbps)

Cable Length		Max Nodes	Notes
Min	Max	Bus Segment	
0	2000 ft/610 m	N/A	5.5 dB/1000 ft max
6 ft/2 m ¹	1000 ft/305 m	8	5.5 dB/1000 ft max
0	3000 ft/915 m	N/A	4.3 dB/km max
0	6000 ft/1825 m	N/A	4.3 dB/km max
0 ²	9000 ft/2740 m	N/A	4.0 dB/km max

Appendix B—Declaration of Conformity

Applied Council Directives:

Electromagnetic Compatibility Directive, 89/336/EEC Council Directive as amended by Council Directive 92/31/EEC & Council Directive 93/68/EEC

Standard to which Conformity is Declared

EN 55022:1995 CISPR22: 1993, Class A, Limits and Methods of Measurement of Radio Disturbance Characteristics of Information Technology Equipment

EN 55024:1998, Information Technology Equipment — Immunity Characteristics — Limits and Methods of Measurement

Manufacturer:

Contemporary Control Systems, Inc.
2431 Curtiss Street
Downers Grove, IL 60515 USA

Authorized Representative:

Contemporary Controls Ltd
Sovereign Court Two
University of Warwick Science Park
Sir William Lyons Road
Coventry CV4 7EZ
UNITED KINGDOM

Type of Equipment:

Industrial network extender

Model	Directive
	EMC
EB/DNET-CXB	Yes
EB/DNET-FOG	Yes

Technical File TD960801-0FA

I, the undersigned, hereby declare that the product(s) specified above conforms to the listed directives and standards.

George M. Thomas, President

April 6, 1999